

REVISIONS			
SYS	DESCRIPTION	DATE	APPROV
C	PER ECN 1242	05/09/14	

UNCONTROLLED

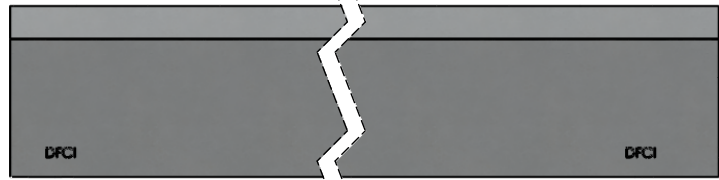
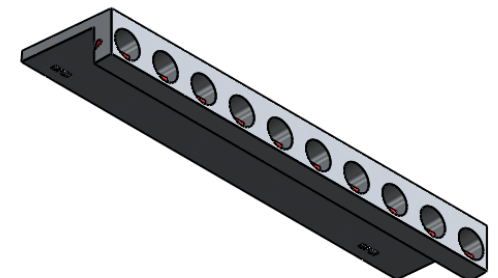
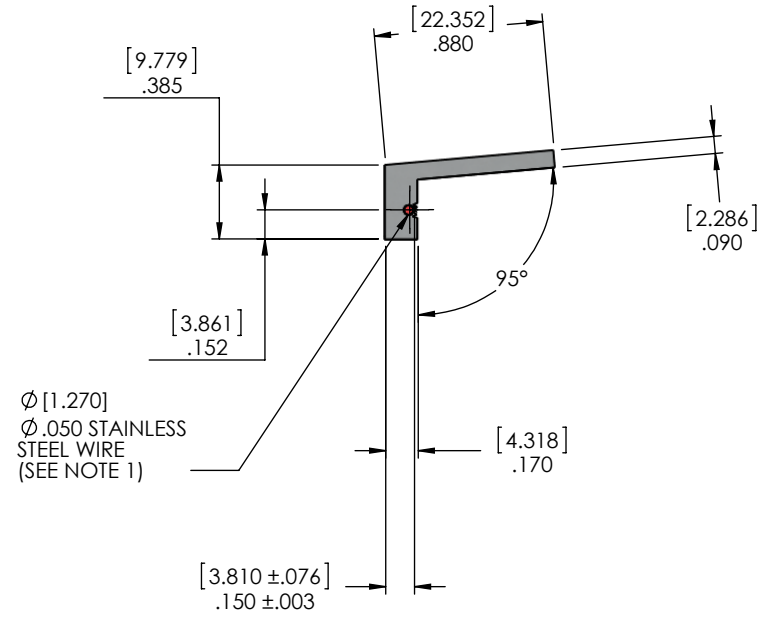
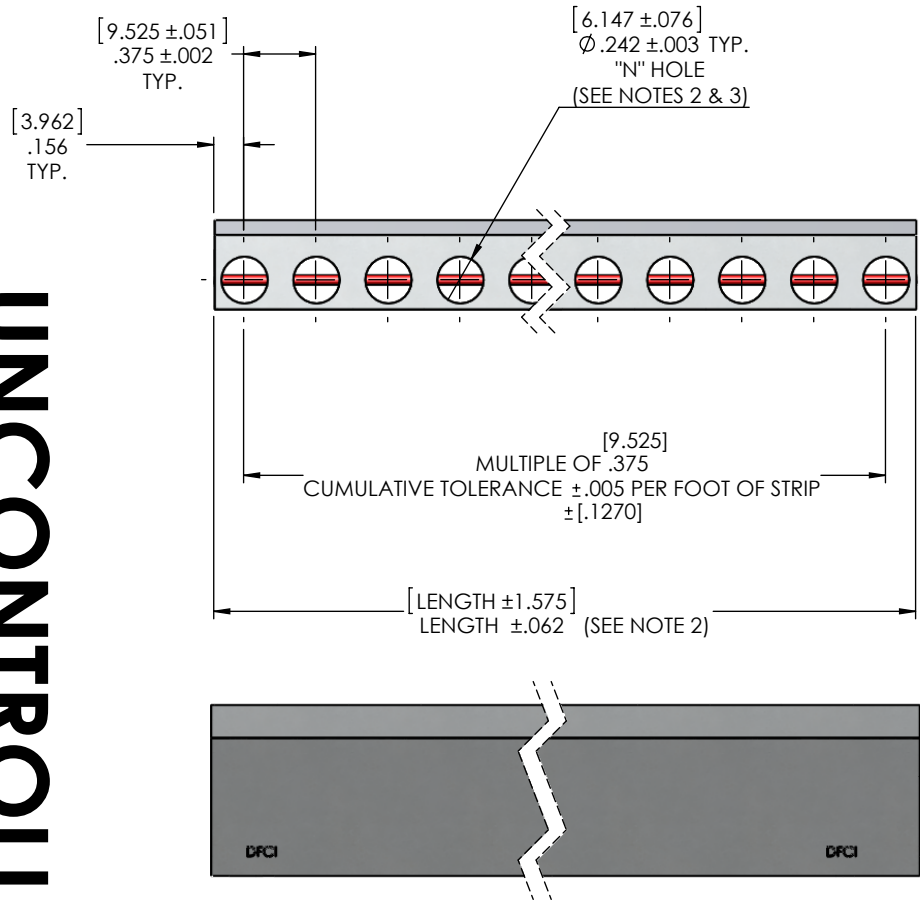

DIMENSIONS SHOWN IN BRACKETS [ ] ARE IN METRIC

MATERIAL:	SEE NOTE 1
HEAT TREAT:	NONE
FINISH:	NONE
THE FASTENER PARTS SHOWN IN THIS PRINT ARE PROPRIETARY ARTICLES TO WHICH DFCI SOLUTIONS INC., RETAINS THE EXCLUSIVE RIGHTS OF MANUFACTURE, USE AND SALE. THE PRINT OR DRAWING IS SUBMITTED IN CONFIDENCE AND DOES NOT CONVEY A LICENSE OR PERMISSION TO MANUFACTURE THE FASTENER OR FASTENER PARTS. (C) COPYRIGHT 2009, DFCI SOLUTIONS INC. ALL RIGHTS RESERVED.	

TOLERANCES ON DIMENSIONS UNLESS OTHERWISE SPECIFIED			
X* = ±2°		.XX = ±.015 [.3810]	
X/X = ±1/32 [.7937]		.XXX = ±.010 [.2540]	
MACHINE FINISH = .125			
PART NO.	SEE TABLES	DRN	Frank Basile
		DATE	06-11-13
		CHK.	Frank Basile
		DATE	06-11-13
		ENG.	Frank Altkorn
		DATE	06-11-13
		MFG.	Rashm Lubman
		DATE	06-11-13
		G.C.	Frank Altkorn
		DATE	06-11-13
NEXT ASSY	USED ON	SALES.	
APPLICATION BLOCK			

**DFCI SOLUTIONS INC.**  
 425 UNION BOULEVARD.  
 WEST ISLIP, NEW YORK 11795

TITLE			
PA-3500 95° RECEPTACLE STRIP 3590-241833-H***			
SIZE	FSCM NO.	DWG. NO.	REV.
A	72794	C3590-241833-H	C
SCALE: NTS		WEIGHT:	SHEET 1 OF 5

# UNCONTROLLED

REVISIONS			
SYS	DESCRIPTION	DATE	APPROV
C	PER ECN 1242	05/09/14	

PART NUMBER	NUMBER OF HOLES
3590-241833-H1	1
3590-241833-H2	2
3590-241833-H3	3
3590-241833-H4	4
3590-241833-H5	5
3590-241833-H6	6
3590-241833-H7	7
3590-241833-H8	8
3590-241833-H9	9
3590-241833-H10	10
3590-241833-H11	11
3590-241833-H12	12
3590-241833-H13	13
3590-241833-H14	14
3590-241833-H15	15
3590-241833-H16	16
3590-241833-H17	17
3590-241833-H18	18
3590-241833-H19	19
3590-241833-H20	20
3590-241833-H21	21
3590-241833-H22	22
3590-241833-H23	23
3590-241833-H24	24
3590-241833-H25	25

PART NUMBER	NUMBER OF HOLES
3590-241833-H26	26
3590-241833-H27	27
3590-241833-H28	28
3590-241833-H29	29
3590-241833-H30	30
3590-241833-H31	31
3590-241833-H32	32
3590-241833-H33	33
3590-241833-H34	34
3590-241833-H35	35
3590-241833-H36	36
3590-241833-H37	37
3590-241833-H38	38
3590-241833-H39	39
3590-241833-H40	40
3590-241833-H41	41
3590-241833-H42	42
3590-241833-H43	43
3590-241833-H44	44
3590-241833-H45	45
3590-241833-H46	46
3590-241833-H47	47
3590-241833-H48	48
3590-241833-H49	49
3590-241833-H50	50

PART NUMBER	NUMBER OF HOLES
3590-241833-H51	51
3590-241833-H52	52
3590-241833-H53	53
3590-241833-H54	54
3590-241833-H55	55
3590-241833-H56	56
3590-241833-H57	57
3590-241833-H58	58
3590-241833-H59	59
3590-241833-H60	60
3590-241833-H61	61
3590-241833-H62	62
3590-241833-H63	63
3590-241833-H64	64
3590-241833-H65	65
3590-241833-H66	66
3590-241833-H67	67
3590-241833-H68	68
3590-241833-H69	69
3590-241833-H70	70
3590-241833-H71	71
3590-241833-H72	72
3590-241833-H73	73
3590-241833-H74	74
3590-241833-H75	75

PART NUMBER	NUMBER OF HOLES
3590-241833-H76	76
3590-241833-H77	77
3590-241833-H78	78
3590-241833-H79	79
3590-241833-H80	80
3590-241833-H81	81
3590-241833-H82	82
3590-241833-H83	83
3590-241833-H84	84
3590-241833-H85	85
3590-241833-H86	86
3590-241833-H87	87
3590-241833-H88	88
3590-241833-H89	89
3590-241833-H90	90
3590-241833-H91	91
3590-241833-H92	92
3590-241833-H93	93
3590-241833-H94	94
3590-241833-H95	95
3590-241833-H96	96
3590-241833-H97	97
3590-241833-H98	98
3590-241833-H99	99
3590-241833-H100	100

DIMENSIONS SHOWN IN BRACKETS [ ] ARE IN METRIC

MATERIAL: SEE NOTE 1	TOLERANCES ON DIMENSIONS UNLESS OTHERWISE SPECIFIED			 <b>DFCI SOLUTIONS INC.</b> 425 UNION BOULEVARD. WEST ISLIP, NEW YORK 11795	TITLE PA-3500 95° RECEPTACLE STRIP 3590-241833-H***	SIZE <b>A</b> FSCM NO. 72794 DWG. NO. C3590-241833-H REV. <b>C</b>	
HEAT TREAT: NONE	X* = ±2° .XX = ±.015 [.3810] MACHINE FINISH = .125 X/X = ±1/32 [.7937] .XXX = ±.010 [.2540]						
FINISH: NONE	PART NO. SEE TABLES	DRN Frank Basile DATE 06/11/13	CHK. Frank Basile DATE 06/11/13				
THE FASTENER PARTS SHOWN IN THIS PRINT ARE PROPRIETARY ARTICLES TO WHICH DFCI SOLUTIONS INC., RETAINS THE EXCLUSIVE RIGHTS OF MANUFACTURE, USE AND SALE. THE PRINT OR DRAWING IS SUBMITTED IN CONFIDENCE AND DOES NOT CONVEY A LICENSE OR PERMISSION TO MANUFACTURE THE FASTENER OR FASTENER PARTS. (C) COPYRIGHT 2009, DFCI SOLUTIONS INC. ALL RIGHTS RESERVED.		ENG. [Signature] DATE 06/11/13	MFG. Radu Irbarn DATE 06/11/13				
	NEXT ASSY	USED ON	G.C. [Signature] DATE 06/11/13	SALES.	SCALE: NTS	WEIGHT:	SHEET 2 OF 5

# UNCONTROLLED

REVISIONS			
SYS	DESCRIPTION	DATE	APPROV
C	PER ECN 1242	05/09/14	

PART NUMBER	NUMBER OF HOLES
3590-241833-H101	101
3590-241833-H102	102
3590-241833-H103	103
3590-241833-H104	104
3590-241833-H105	105
3590-241833-H106	106
3590-241833-H107	107
3590-241833-H108	108
3590-241833-H109	109
3590-241833-H110	110
3590-241833-H111	111
3590-241833-H112	112
3590-241833-H113	113
3590-241833-H114	114
3590-241833-H115	115
3590-241833-H116	116
3590-241833-H117	117
3590-241833-H118	118
3590-241833-H119	119
3590-241833-H120	120
3590-241833-H121	121
3590-241833-H122	122
3590-241833-H123	123
3590-241833-H124	124
3590-241833-H125	125

PART NUMBER	NUMBER OF HOLES
3590-241833-H126	126
3590-241833-H127	127
3590-241833-H128	128
3590-241833-H129	129
3590-241833-H130	130
3590-241833-H131	131
3590-241833-H132	132
3590-241833-H133	133
3590-241833-H134	134
3590-241833-H135	135
3590-241833-H136	136
3590-241833-H137	137
3590-241833-H138	138
3590-241833-H139	139
3590-241833-H140	140
3590-241833-H141	141
3590-241833-H142	142
3590-241833-H143	143
3590-241833-H144	144
3590-241833-H145	145
3590-241833-H146	146
3590-241833-H147	147
3590-241833-H148	148
3590-241833-H149	149
3590-241833-H150	150

PART NUMBER	NUMBER OF HOLES
3590-241833-H151	151
3590-241833-H152	152
3590-241833-H153	153
3590-241833-H154	154
3590-241833-H155	155
3590-241833-H156	156
3590-241833-H157	157
3590-241833-H158	158
3590-241833-H159	159
3590-241833-H160	160
3590-241833-H161	161
3590-241833-H162	162
3590-241833-H163	163
3590-241833-H164	164
3590-241833-H165	165
3590-241833-H166	166
3590-241833-H167	167
3590-241833-H168	168
3590-241833-H169	169
3590-241833-H170	170
3590-241833-H171	171
3590-241833-H172	172
3590-241833-H173	173
3590-241833-H174	174
3590-241833-H175	175

PART NUMBER	NUMBER OF HOLES
3590-241833-H176	176
3590-241833-H177	177
3590-241833-H178	178
3590-241833-H179	179
3590-241833-H180	180
3590-241833-H181	181
3590-241833-H182	182
3590-241833-H183	183
3590-241833-H184	184
3590-241833-H185	185
3590-241833-H186	186
3590-241833-H187	187
3590-241833-H188	188
3590-241833-H189	189
3590-241833-H190	190
3590-241833-H191	191
3590-241833-H192	192
3590-241833-H193	193
3590-241833-H194	194
3590-241833-H195	195
3590-241833-H196	196
3590-241833-H197	197
3590-241833-H198	198
3590-241833-H199	199
3590-241833-H200	200

**DIMENSIONS SHOWN IN BRACKETS [ ] ARE IN METRIC**

MATERIAL: SEE NOTE 1	TOLERANCES ON DIMENSIONS UNLESS OTHERWISE SPECIFIED	
HEAT TREAT: NONE	$X^* = \pm 2^*$ .XX = $\pm 0.015$ [.3810] $X/X = \pm 1/32$ [.7937] .XXX = $\pm 0.010$ [.2540] MACHINE FINISH = .125	
FINISH: NONE	PART NO. SEE TABLES	DRN. <i>Frank Basile</i> DATE 06/11/13
THE FASTENER PARTS SHOWN IN THIS PRINT ARE PROPRIETARY ARTICLES TO WHICH DFCI SOLUTIONS INC., RETAINS THE EXCLUSIVE RIGHTS OF MANUFACTURE, USE AND SALE. THE PRINT OR DRAWING IS SUBMITTED IN CONFIDENCE AND DOES NOT CONVEY A LICENSE OR PERMISSION TO MANUFACTURE THE FASTENER OR FASTENER PARTS. (C) COPYRIGHT 2009, DFCI SOLUTIONS INC. ALL RIGHTS RESERVED.		CHK. <i>Frank Basile</i> DATE 06/11/13
		ENG. <i>Bob Altkorn</i> DATE 06/11/13
		MFG. <i>Rashad Ibrahim</i> DATE 06/11/13
		G.C. <i>Bob Altkorn</i> DATE 06/11/13
	NEXT ASSY USED ON	SALES. DATE
	APPLICATION BLOCK	



**DFCI SOLUTIONS INC.**  
 425 UNION BOULEVARD.  
 WEST ISLIP, NEW YORK 11795

TITLE PA-3500 95° RECEPTACLE STRIP 3590-241833-H***			
SIZE A	FSCM NO. 72794	DWG. NO. C3590-241833-H	REV. C
SCALE: NTS		WEIGHT:	SHEET 3 OF 5

# UNCONTROLLED

REVISIONS			
SYS	DESCRIPTION	DATE	APPROV
C	PER ECN 1242	05/09/14	

PART NUMBER	NUMBER OF HOLES
3590-241833-H201	201
3590-241833-H202	202
3590-241833-H203	203
3590-241833-H204	204
3590-241833-H205	205
3590-241833-H206	206
3590-241833-H207	207
3590-241833-H208	208
3590-241833-H209	209
3590-241833-H210	210
3590-241833-H211	211
3590-241833-H212	212
3590-241833-H213	213
3590-241833-H214	214
3590-241833-H215	215
3590-241833-H216	216
3590-241833-H217	217
3590-241833-H218	218
3590-241833-H219	219
3590-241833-H220	220
3590-241833-H221	221
3590-241833-H222	222
3590-241833-H223	223
3590-241833-H224	224
3590-241833-H225	225

PART NUMBER	NUMBER OF HOLES
3590-241833-H226	226
3590-241833-H227	227
3590-241833-H228	228
3590-241833-H229	229
3590-241833-H230	230
3590-241833-H231	231
3590-241833-H232	232
3590-241833-H233	233
3590-241833-H234	234
3590-241833-H235	235
3590-241833-H236	236
3590-241833-H237	237
3590-241833-H238	238
3590-241833-H239	239
3590-241833-H240	240
3590-241833-H241	241
3590-241833-H242	242
3590-241833-H243	243
3590-241833-H244	244
3590-241833-H245	245
3590-241833-H246	246
3590-241833-H247	247
3590-241833-H248	248
3590-241833-H249	249
3590-241833-H250	250

PART NUMBER	NUMBER OF HOLES
3590-241833-H251	251
3590-241833-H252	252
3590-241833-H253	253
3590-241833-H254	254
3590-241833-H255	255
3590-241833-H256	256
3590-241833-H257	257
3590-241833-H258	258
3590-241833-H259	259
3590-241833-H260	260
3590-241833-H261	261
3590-241833-H262	262
3590-241833-H263	263
3590-241833-H264	264
3590-241833-H265	265
3590-241833-H266	266
3590-241833-H267	267
3590-241833-H268	268
3590-241833-H269	269
3590-241833-H270	270
3590-241833-H271	271
3590-241833-H272	272
3590-241833-H273	273
3590-241833-H274	274
3590-241833-H275	275

PART NUMBER	NUMBER OF HOLES
3590-241833-H276	276
3590-241833-H277	277
3590-241833-H278	278
3590-241833-H279	279
3590-241833-H280	280
3590-241833-H281	281
3590-241833-H282	282
3590-241833-H283	283
3590-241833-H284	284
3590-241833-H285	285
3590-241833-H286	286
3590-241833-H287	287
3590-241833-H288	288
3590-241833-H289	289
3590-241833-H290	290
3590-241833-H291	291
3590-241833-H292	292
3590-241833-H293	293
3590-241833-H294	294
3590-241833-H295	295
3590-241833-H296	296
3590-241833-H297	297
3590-241833-H298	298
3590-241833-H299	299
3590-241833-H300	300

DIMENSIONS SHOWN IN BRACKETS [ ] ARE IN METRIC

MATERIAL: SEE NOTE 1	TOLERANCES ON DIMENSIONS UNLESS OTHERWISE SPECIFIED X* = ±2* .XX = ±.015 [.3810] MACHINE FINISH = .125 X/X = ±1/32 [.7937] .XXX = ±.010 [.2540]			DFCI SOLUTIONS INC. 425 UNION BOULEVARD. WEST ISLIP, NEW YORK 11795	
HEAT TREAT: NONE	PART NO. SEE TABLES	DRN. Frank Basile DATE 06/11/13		TITLE PA-3500 95° RECEPTACLE STRIP 3590-241833-H***	
FINISH: NONE		CHK. Frank Basile DATE 06/11/13	SIZE A		
THE FASTENER PARTS SHOWN IN THIS PRINT ARE PROPRIETARY ARTICLES TO WHICH DFCI SOLUTIONS INC., RETAINS THE EXCLUSIVE RIGHTS OF MANUFACTURE, USE AND SALE. THE PRINT OR DRAWING IS SUBMITTED IN CONFIDENCE AND DOES NOT CONVEY A LICENSE OR PERMISSION TO MANUFACTURE THE FASTENER OR FASTENER PARTS. (C) COPYRIGHT 2009, DFCI SOLUTIONS INC. ALL RIGHTS RESERVED.			ENG. Frank Basile DATE 06/11/13	DWG. NO. C3590-241833-H	
	NEXT ASSY	USED ON	G.C. Frank Basile DATE 06/11/13	SCALE: NTS	WEIGHT:
	APPLICATION BLOCK		SALES.		SHEET 4 OF 5

# UNCONTROLLED

REVISIONS			
SYS	DESCRIPTION	DATE	APPROV
C	PER ECN 1242	05/09/14	

PART NUMBER	NUMBER OF HOLES
3590-241833-H301	301
3590-241833-H302	302
3590-241833-H303	303
3590-241833-H304	304
3590-241833-H305	305
3590-241833-H306	306
3590-241833-H307	307
3590-241833-H308	308
3590-241833-H309	309
3590-241833-H310	310
3590-241833-H311	311
3590-241833-H312	312
3590-241833-H313	313
3590-241833-H314	314
3590-241833-H315	315
3590-241833-H316	316
3590-241833-H317	317
3590-241833-H318	318
3590-241833-H319	319
3590-241833-H320	320

**NOTES:**

- MATERIAL:**  
RECEPTACLE STRIP: 6061-T6 ALUMINUM ALLOY PER QQ-A-200/8  
WIRE: 050 DIA. STAINLESS STEEL TYPE 316 PER ASTM-A-313, SPRING TEMPER
- THE CUT LENGTH OF THE PART IS CALCULATED AS FOLLOWS:**  
TOTAL LENGTH=(N-1)(.375)+.312  
EXAMPLE: 3590-241833-H50 (50-1)(.375)+.312=18.687 IN.  
METRIC EXAMPLE: 3590-241833-H50 (50-1)(9.525)+7.924= 474.649mm  
  
THE NUMBER OF "N" HOLES PER PART ARE CALLED OUT IN THE PART NUMBER  
EXAMPLE:3590-241833-H50 (H50 INDICATES 50 HOLES PER STRIP)
- SOME DISTORTION MAY ENTER THE .242 DIA. HOLE DUE TO STAKING OF WIRE. THIS WILL NOT AFFECT THE FUNCTION OF THE PART.**
- PLEASE VISIT [www.dfci.com/c3590-241833](http://www.dfci.com/c3590-241833) FOR A LIST OF AVAILABLE FINISHES.**
- REMOVE ALL BURRS & BREAK SHARP CORNERS.**
- ALL CORNERS & FILLETS .005 MAX.**

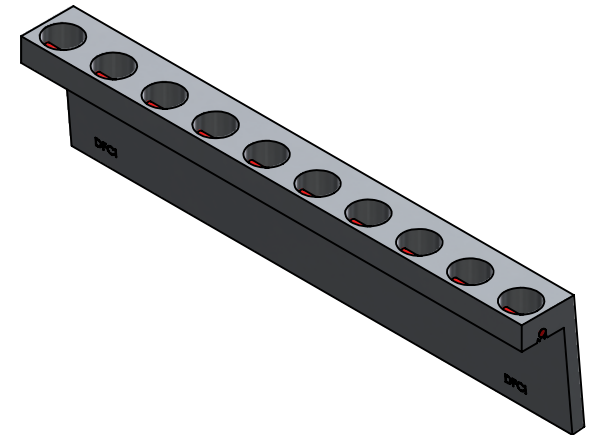

**DIMENSIONS SHOWN IN BRACKETS [ ] ARE IN METRIC**

MATERIAL: SEE NOTE 1	TOLERANCES ON DIMENSIONS UNLESS OTHERWISE SPECIFIED X" = ±2° .XX = ±.015 [.3810] X/X = ±1/32 [.7938] .XXX = ±.010 [.2540] MACHINE FINISH = .125			 <b>DFCI SOLUTIONS INC.</b> 425 UNION BOULEVARD. WEST ISLIP, NEW YORK 11795
HEAT TREAT: NONE	PART NO. SEE TABLES	DRN <i>Frank Basile</i> DATE 06/11-13	CHK. <i>Frank Basile</i> DATE 06/11-13	
FINISH: NONE		ENG. <i>Frank Basile</i> DATE 06/11-13	ENG. <i>Frank Basile</i> DATE 06/11-13	
THE FASTENER PARTS SHOWN IN THIS PRINT ARE PROPRIETARY ARTICLES TO WHICH DFCI SOLUTIONS INC., RETAINS THE EXCLUSIVE RIGHTS OF MANUFACTURE, USE AND SALE. THE PRINT OR DRAWING IS SUBMITTED IN CONFIDENCE AND DOES NOT CONVEY A LICENSE OR PERMISSION TO MANUFACTURE THE FASTENER OR FASTENER PARTS. (C) COPYRIGHT 2009, DFCI SOLUTIONS INC. ALL RIGHTS RESERVED.		MFG. <i>Rashm Lubman</i> DATE 06/11-13	MFG. <i>Rashm Lubman</i> DATE 06/11-13	
	NEXT ASSY	USED ON	Q.C. <i>Frank Basile</i> DATE 06/11-13	Q.C. <i>Frank Basile</i> DATE 06/11-13
	APPLICATION BLOCK	SALES.	DATE	TITLE: PA-3500 95° RECEPTACLE STRIP 3590-241833-H*** SIZE: A FSCM NO: 72794 DWG. NO. C3590-241833-H REV. C SCALE: NTS WEIGHT: SHEET 5 OF 5